

JETYD

Operations Manual

jGun

Dual Speed jGun

FRL Unit

LoaDisc Reaction Washer

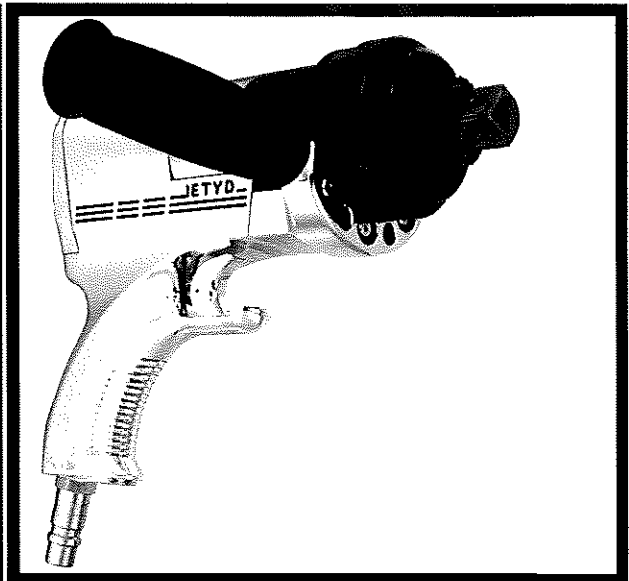

JETYD Corporation
218 Island Road
Mahwah, NJ 07430
Phone: 201.828.5270
Fax: 201.828.5224
Email: info@jetyd.com

Contents

Warranty vi

Certification vi

jGun Overview 1

jGun Safety 1

 Personal Protective Equipment..... 1

 Air Supply Requirements 2

 Reaction Arm or Washer..... 2

 Reaction Arm and Socket Installation 6

 Key Operating Safety Points..... 9

jGun Setup and Use..... 11

 Setting a Torque Value 11

 Changing the Drive Direction 12

 Operating the jGun..... 12

 Loosening a Fastener 14

jGun Repair and Maintenance 14

 Maintaining Hoses and Fittings..... 14

 Removing the Square Drive..... 15

 Installing the Square Drive..... 16

 Lubricating the Air Motor..... 16

 Removing the Air Motor 17

 Calibration..... 17

Dual Speed jGun..... 18

 Shifting Between Modes 19

 Tool Operation 20

 Operation with a Socket and Reaction Arm 20

 Operation with a Load Disc..... 21

jGun Single Speed Parts Diagram 22

jGun Single Speed Parts List..... 23

jGun Dual Speed Parts Diagram..... 24

jGun Dual Speed Parts List..... 25

Filter/Regulator/Lubricator (FRL) Unit Overview 26

 FRL Safety 26

 Personal Protective Equipment..... 27

| | |
|---|----|
| Air Supply Requirements | 27 |
| FRL Setup and Use | 28 |
| Important FRL Operating Procedures..... | 28 |
| Emptying the Filter Reservoir..... | 28 |
| Adjusting Air Pressure | 30 |
| Filling the Lubricator Reservoir | 31 |
| Adjusting the Flow..... | 32 |
| Repair and Maintenance..... | 32 |
| Hoses and Fittings | 32 |
| LoaDisc Reaction Washer Overview | 33 |
| Safety | 34 |
| Personal Protective Equipment..... | 34 |
| LoaDisc Requirements..... | 35 |
| LoaDisc Setup and Use | 35 |
| Important Preparation Procedures..... | 35 |
| Important Installation Procedures | 35 |

Figures

| | | |
|------------|--|----|
| Figure 1. | Reaction Arm..... | 3 |
| Figure 2. | LoaDisc and Socket | 3 |
| Figure 3. | Installing a Reaction Arm | 6 |
| Figure 4. | Reaction Arm Installed | 7 |
| Figure 5. | Tightening Reaction Arm Set Screw..... | 7 |
| Figure 6. | Installing jGun Socket..... | 8 |
| Figure 7. | Installing Socket Locking Pin and Retaining Ring | 8 |
| Figure 8. | Placement of Reaction Arm..... | 9 |
| Figure 9. | jGun Drive Direction Lever | 12 |
| Figure 10. | jGun Operation | 13 |
| Figure 11. | Using the jGun with a Reaction Washer..... | 14 |
| Figure 12. | Removing the jGun Square Drive Snap Ring | 15 |
| Figure 13. | Dual Speed jGun with Handle | 18 |
| Figure 14. | Maximum Torque Setting (Left) and Maximum Speed Setting (Right)..... | 19 |
| Figure 15. | Reaction Arm for dual-speed jGun | 20 |
| Figure 16. | FRL Unit | 26 |
| Figure 17. | Emptying the FRL Filter Reservoir | 29 |
| Figure 18. | Detaching FRL Reservoir | 29 |
| Figure 19. | FRL Unit – Lubricator 2/3rds Full of Oil | 30 |
| Figure 20. | Adjusting FRL Regulator | 31 |
| Figure 21. | Adjusting FRL Oil Flow | 32 |
| Figure 22. | LoaDisc Washer and Socket | 33 |
| Figure 23. | LoaDisc Socket Mounted on jGun..... | 34 |
| Figure 24. | LoaDisc Washer Installed..... | 36 |
| Figure 25. | Aligning LoaDisc Socket Set Screw with Machined Recess in jGun Splines | 37 |
| Figure 26. | Tightening LoaDisc Set Screw | 37 |

Tables

| | | |
|----------|---------------------------------|----|
| Table 1. | Bolt Torque Specifications..... | 11 |
|----------|---------------------------------|----|

jGun Overview

The jGun pneumatic torque wrench is designed to safely and accurately deliver up to 5,200 ft-lbs of torque onto a fastener. This is accomplished using a patented planetary gearbox torque multiplier system and an appropriate reaction arm or LoaDisc™ Reaction Washer. The torque multiplier produces torque ratios of up to 700:1 while the reaction arm or washer is used to absorb the high counter rotational force produced as the final torque value is reached. At final torque value, the jGun safely stalls out, leaving the fastener tightened to specification.

Unlike impact wrenches, the jGun never transmits working torque to the operator. The torque is applied between the fastener and the reaction surface.

This manual provides information for both the standard jGun and the dual-speed jGun.

jGun Safety

Only qualified personnel who have thoroughly read this document may operate this tool. Failure to safely operate this tool may result in serious injury or death.

- Inspect all jGun components as they are removed from the shipping container. If damage is found to any component, contact your shipper immediately. Do not use the tool.
- Failure to follow correct tool usage could result in personal injury, co-worker injury, and/or damaged tools and equipment.
- Ensure your working area is clean and unobstructed before beginning work.
- jGun maintenance and repair must be performed by a qualified pneumatic technician.
- Modifying a jGun or jGun accessory is dangerous and invalidates the warranty.
- Inspect the tool before each use. Replace any obviously worn or damaged parts.
- When not in use, store the jGun and jGun accessories in the plastic storage case supplied with the tool. Do not expose the gun to high humidity or large temperature variations.

Personal Protective Equipment

- Always wear the appropriate personal protective equipment when operating a jGun including gloves, safety goggles, hearing protection, hard hat, and safety shoes

Warranty

The j-Gun has a one year limited warranty. Every JETYD tool is tested before leaving the factory and is warranted to be free from defects in workmanship and materials. JETYD will repair or replace, without charge, any tool which upon examination proves to be defective in workmanship or materials for one (1) year after the date of purchase. This warranty does not cover damage from repairs made or attempted by other than JETYD authorized personnel, abuse, normal wear and tear, lack of maintenance, or accidents.

The repair and replacement remedies described herein are exclusive. In no event shall JETYD be liable for any incidental, special, or consequential damages, including loss of profits.

This warranty is exclusive and in lieu of all other warranties or conditions, written or oral, expressed or implied for merchantability or fitness for particular use or purpose.

This warranty gives you specific legal rights. You may also have other rights that vary from state to state and province to province. In those states that do not allow the exclusion of implied warranties or limitation of incidental or consequential damages, the above limitations or exclusions may not apply to you.

If you have questions about the **JETYD** warranty, contact our customer service center at +1 201 828-5270.

Certification

The jGun is certified according to tests performed to the EN 1127-1: 1997 standard.



II 2G c IIB T6

Air Supply Requirements

- The air supply line must be ½-inch minimum diameter to allow adequate air flow to the jGun.
- The air supply must provide a minimum of 90 PSI at 30 CFM.
- Ensure that air line fittings are tight and leak free. Do not over tighten air line fittings.
- Always use the Filter Regulator Lubricator (FRL) Unit provided with the jGun. Never use a substitute oiler and regulator.

NOTE

Set the air pressure at the FRL *while the tool is running* as described in FRL Setup and Use.

- Open the air supply connected to the FRL unit and run the jGun while setting the pressure on the regulator gauge.
- Set the air pressure to the PSI needed to achieve desired torque shown on the provided pressure/torque conversion chart, also shown in Pressure / Torque Conversion Charts.

Reaction Arm or Washer

- Choose the correct reaction arm for the job. The jGun is shipped with a standard length reaction arm, but your gun may have been ordered with a custom reaction arm for a specific purpose.

Figure 1. Reaction Arm



- The universal LoadDisc™ reaction washer may be used for all applications in place of a standard reaction arm.

Figure 2. LoadDisc and Socket

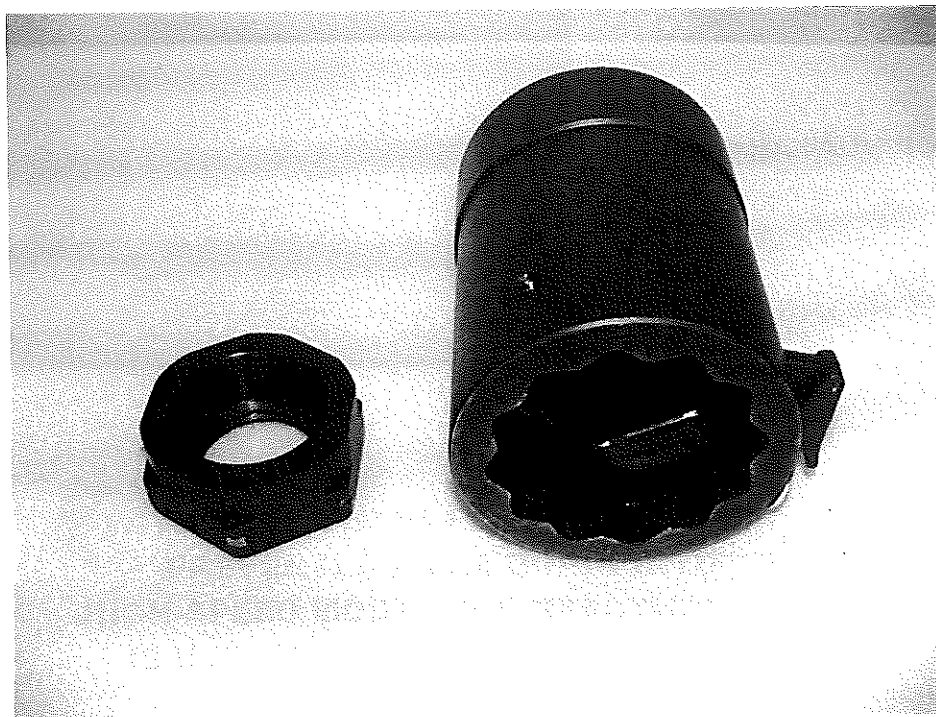

- Never modify a reaction arm.



▲ CAUTION

Never modify a reaction arm. Modifying a reaction arm may cause personal injury and tool damage.



NOTE

Modifying a reaction arm voids the reaction arm and jGun warranty. Contact the jGun factory to have a custom reaction arm manufactured.

WARNING

DUAL-SPEED GUNS MUST ONLY BE OPERATED WITH THE PROPER REACTION ARM SHOWN IN THE PICTURE BELOW.

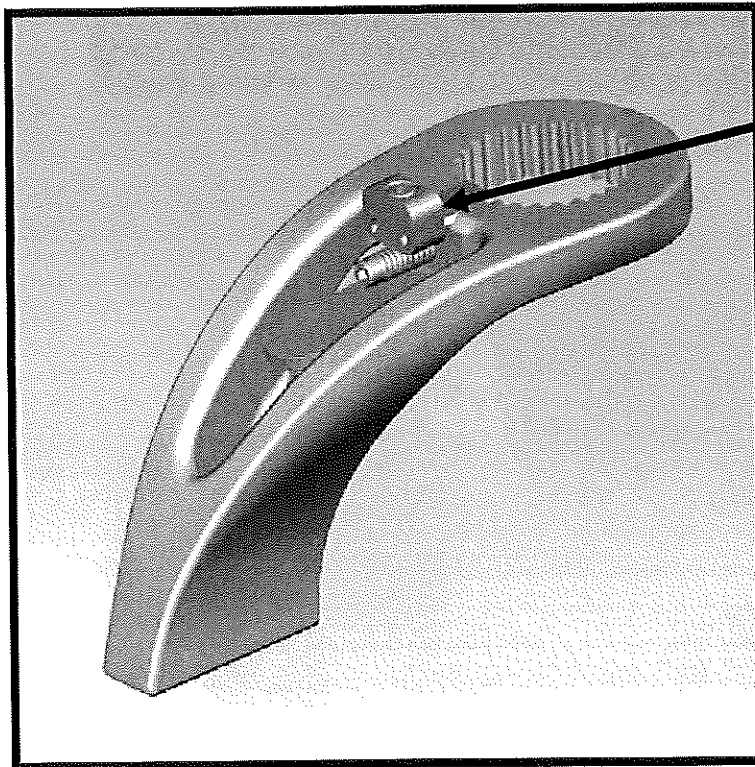

SAFETY APPARATUS MUST NOT BE TAMPERED WITH. DOING SO WILL PUT THE OPERATOR AT RISK OF INJURY.

WITH THIS ARM IN PLACE THE GUN IS PREVENTED FROM GOING INTO HIGH-SPEED MODE. THE REACTION ARM IS NOT USED IN HIGH SPEED MODE.

Reaction Arm and Socket Installation

- Choose the correct reaction arm for the job. The jGun is shipped with a standard length reaction arm, but your gun may have been ordered with custom-length reaction arm for a specific purpose.
- If using the LoadDisc™ reaction washer, follow installation instructions in [LoadDisc Reaction Washer Overview](#).
- Clean the reaction arm and jGun barrel mating surfaces before installing the reaction arm.
- Slide the reaction arm onto the jGun barrel with the reaction arm extension facing out.

Figure 3. Installing a Reaction Arm

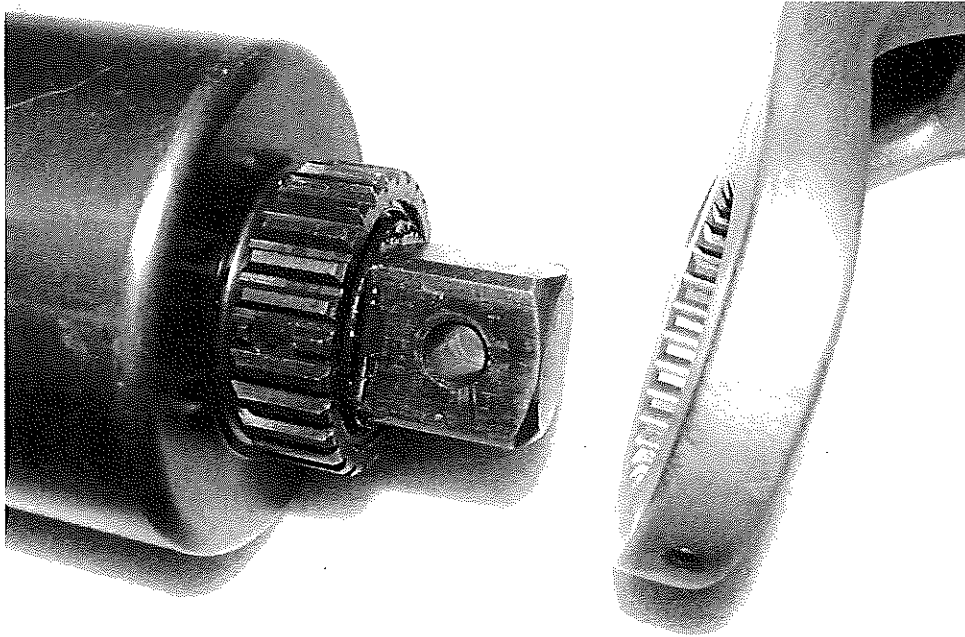

CAUTION

Always install the reaction arm with the extension facing away from the gun.

Failure to install the reaction arm correctly could result in the reaction arm coming in contact with your hand or other another part of your body, causing personal injury.

Figure 4. Reaction Arm Installed



- Lock the reaction arm to the jGun by aligning the set-screw with the hole in the splined section and then tightening the set screw firmly.

Figure 5. Tightening Reaction Arm Set Screw

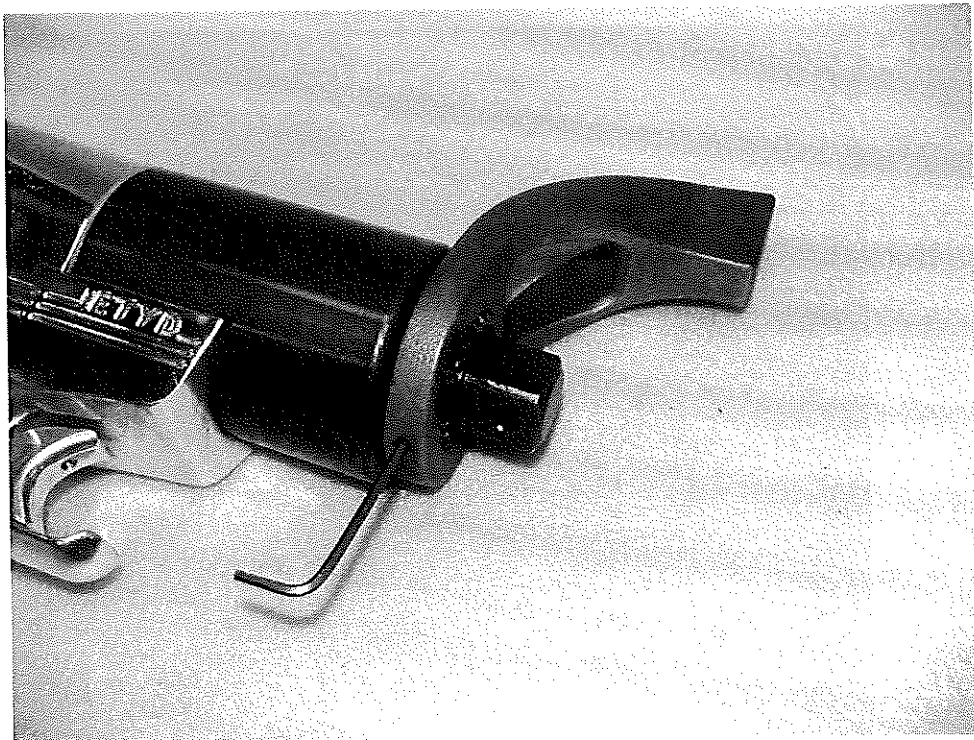

- Place the appropriately sized socket onto the jGun barrel.

Figure 6. Installing jGun Socket



- Install the socket locking pin and retaining ring.

Figure 7. Installing Socket Locking Pin and Retaining Ring

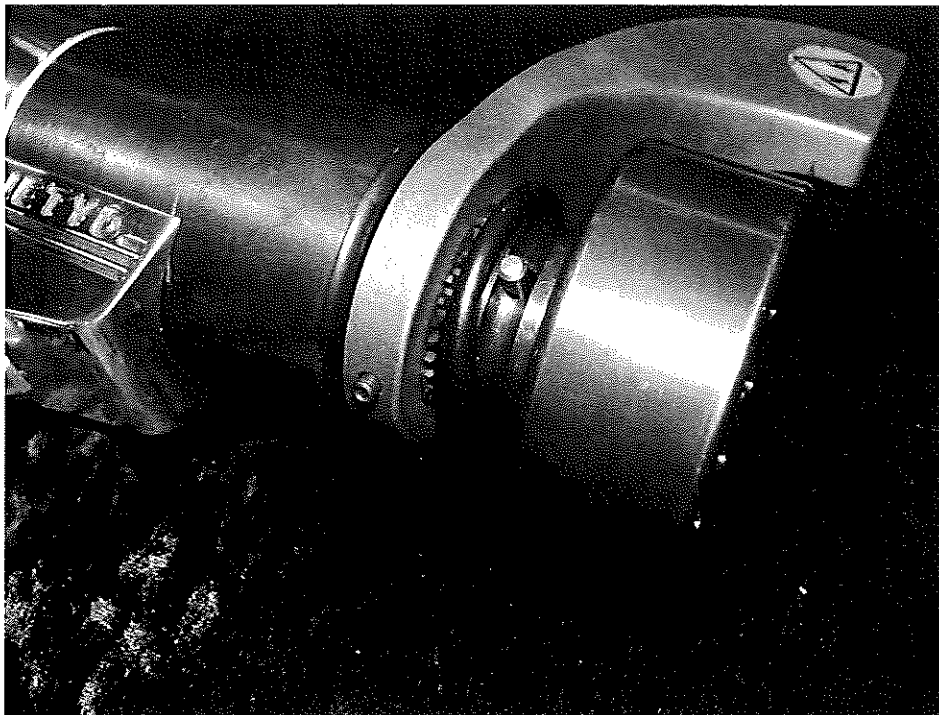

Key Operating Safety Points

- Ensure that the reaction arm is in direct contact with an appropriate immovable object before beginning to tighten the fastener.

Figure 8. Placement of Reaction Arm

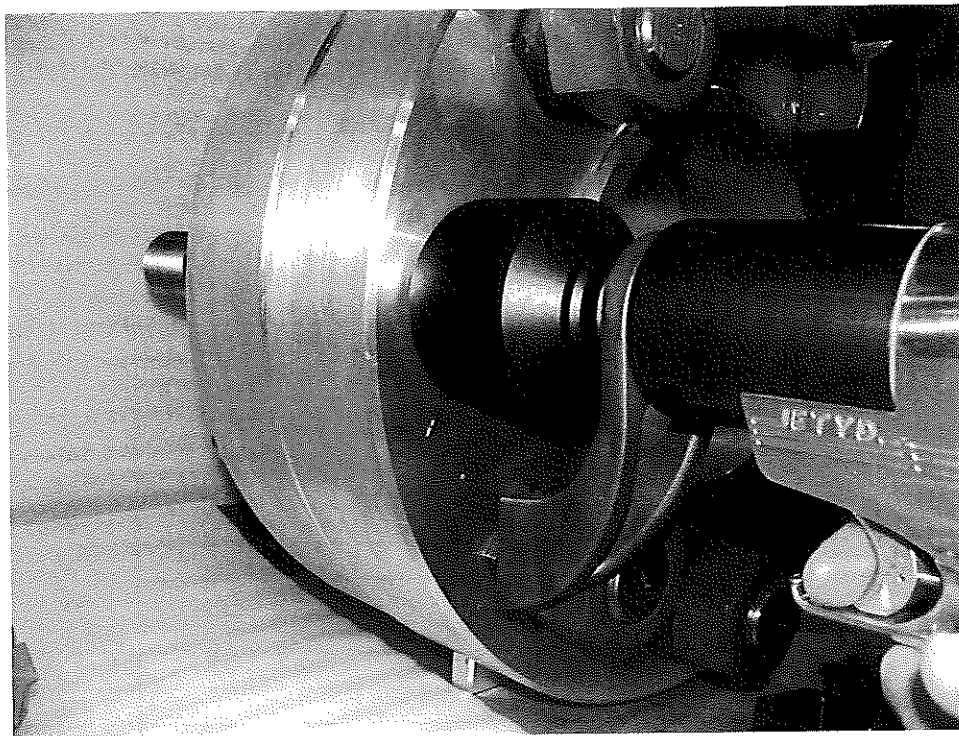

- Using the LoadDisc™ reaction washer eliminates external moving parts and increases worker safety. Refer to [LoadDisc Reaction Washer Overview](#).

▲ CAUTION



Failure to have the reaction arm in direct contact with an appropriate immovable object before beginning to tighten the fastener could result in loss of control of the tool and personal injury.

- Keep all body parts clear of the reaction arm and reaction arm contact point (immovable object).



▲ CAUTION

Do not place any part of your body between the reaction arm and an appropriate immovable object at any time while a fastener is being torqued.

Personal injury may occur if any portion of your body is located between the reaction arm and the immovable object when the fastener is being torqued.

- Ensure the jGun barrel is in a straight line with relation to the stud and that the socket is fully engaged onto the fastener.
- As the tool takes up the bolt load, the jGun may shift.

jGun Setup and Use

Proper setup and use of the jGun before and during installation ensures accurate results and safe operation. The FRL Unit provided with the jGun must be used with the hose provided to ensure the tool's durability. See the [FRL Unit Overview](#) section below for more information.

Proper installation and use of reaction arms increases worker safety and job efficiency. The LoadDisc reaction washer is a universal solution for tool reaction on all applications and may be used in place of a reaction arm. See [LoadDisc Reaction Washer Overview](#) for more details.

Setting a Torque Value

1. Determine the torque value for the fastener to be tightened, as shown in the [Bolt Torque Specifications](#) table.

Table 1. Bolt Torque Specifications

| SAE1 SAE2 30,000PSI | ASTM 193 Grade B7 Bolt | Gr. 7 A/F Heavy Hex Nut | Foot Pounds | Estimated Load |
|------------------------|---------------------------|----------------------------|-------------|----------------|
| 1 inch | 7/8 inch | 1-7/16 inches | 300 | 18,150 lbf |
| 1-1/8 inches | 1 inch | 1-5/8 inches | 425 | 23,690 lbf |
| 1-1/4 inches | | | 600 | 29,955 lbf |
| 1-3/8 inches | 1-1/8 inches | 1-3/16 inches | 700 | 36,990 lbf |
| | 1-1/4 inches | 2 inches | 800 | 46,776 lbf |
| 1-1/2 inches | | | 900 | 44,760 lbf |
| 1-5/8 inches | 1-3/8 inches | 2-3/16 inches | 1,250 | 53,400 lbf |
| | 1-1/2 inches | 2-3/8 inches | 1,500 | 64,617 lbf |
| 1-3/4 inches | | | 1,600 | 62,400 lbf |
| 1-7/8 inches | | | 1,800 | 72,300 lbs |
| | 1-5/8 inches | 2-9/16 inches | 2,000 | 76,540 lbs |
| 2 inches | | | 2,200 | 83,100 lbs |
| | 1-3/4 inches | 2-3/4 inches | 2,600 | 89,440 lbs |
| 2-1/4 inches | | | 3,000 | 106,800 lbs |
| | 1-7/8 inches | 2-15/16 inches | 3,700 | 110,680 lbs |
| 2-1/2 inches | 2 inches | 3-1/8 inches | 4,000 | 133,200 lbs |
| 2-3/4 inches | | | 5,100 | 162,900 lbs |
| | 2-1/4 inches | 3-1/2 inches | 6,000 | 168,200 lbs |
| 3 inches | | | 7,000 | 195,300 lbs |
| | 2-1/2 inches | 3-7/8 inches | 8,000 | 213,120 lbs |
| 3-1/4 inches | | | 9,000 | 230,700 lbs |
| 3-1/2 inches | 2-3/4 inches | 4-1/4 inches | 10,000 | 268,800 lbs |
| 3-3/4 inches | 3 inches | 4-5/8 inches | 13,000 | 310,200 lbs |
| 4 inches | | | 14,500 | 354,000 lbs |
| | 3-1/4 inches | 5 inches | 16,500 | 369,120 lbs |
| 4-1/4 inches | | | 19,500 | 401,400 lbs |

The Data Above is based on bolts lubricated to manufacturer's specifications. Due to a variation in friction, we recommend in extreme cases to check with the bolt manufacturer, as the chart represents a guideline only.

2. Determine the air pressure needed to achieve the desired torque by consulting the Pressure/Torque Conversion Chart provided with each tool.
3. Open the air supply connected to the FRL unit and run the torque wrench while setting the pressure on the gauge.

NOTE

The torque wrench must be running while the pressure is being set. When the torque wrench is stopped, the gauge displays a slightly higher pressure than was set with the jGun running. This is normal, proper torque is delivered under working load.

Changing the Drive Direction

1. To change the square drive direction from forward to reverse or vice versa:
2. Move the directional lever on the back cover to the left (**Tighten**) or right (**Loosen**).

Figure 9. jGun Drive Direction Lever

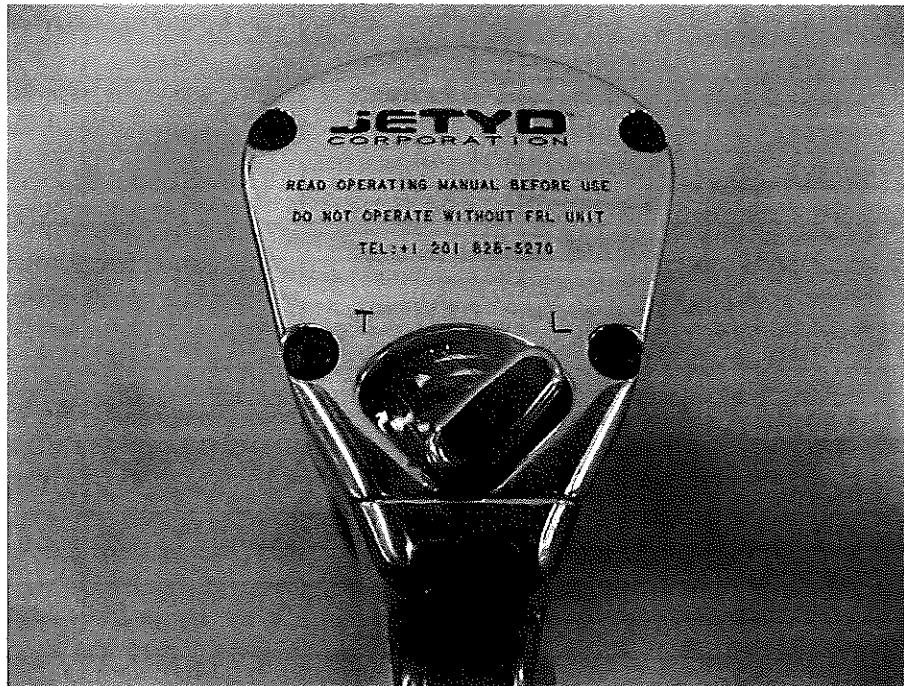

3. Be sure the lever is fully engaged in either direction before operating the gun.

Operating the jGun

To operate the jGun:

1. Place the correct size impact socket on the square drive and secure it with the locking pin and ring.
2. Ensure that the square drive is fully engaged into the socket.

3. Engage the socket onto the nut.
4. Make sure the socket is fully engaged onto the nut.
5. Ensure that the reaction arm is placed firmly against a stationary surface such as an adjacent nut, a flange, or equipment housing. (If using the LoaDisc™ reaction washer in place of a standard reaction arm ensure that it is setup according to the steps in the LoaDisc Reaction Washer Overview section.)
6. Apply momentary pressure to the torque wrench trigger to ensure proper socket engagement and reaction arm placement.

Figure 10. jGun Operation

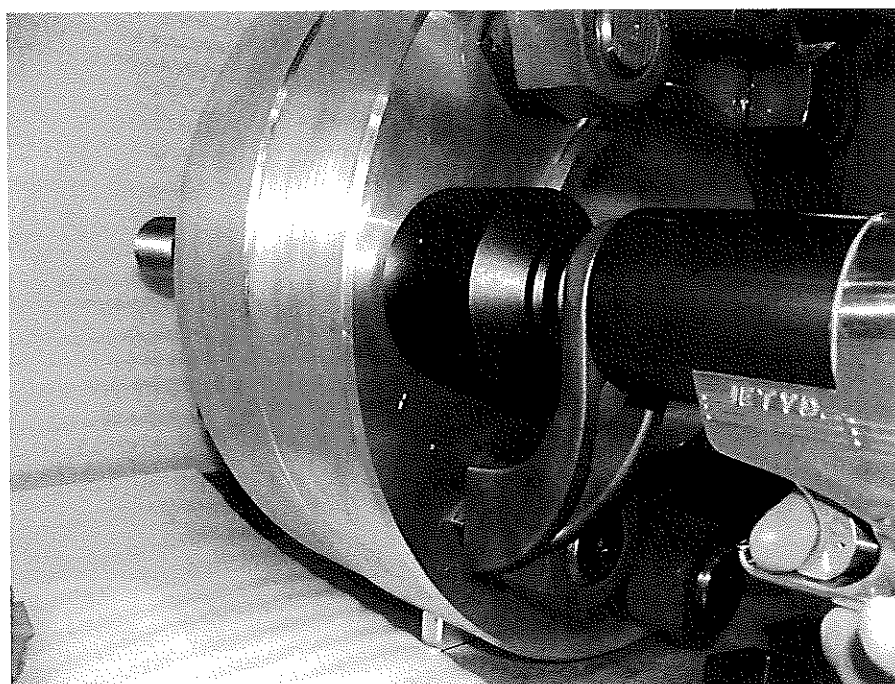

7. Torque the fastener by depressing the trigger until socket stops turning and air bypasses the motor.



▲ CAUTION

Be sure the reaction arm is fully engaged and located on a solid, secure reaction point. For added safety, remain clear of the rear of the reaction arm during operation. Also, when initially applying the tool, pressurize the system momentarily; if the tool tends to ride up or creep, stop and readjust the reaction arm to a more solid and secure position.

Loosening a Fastener

1. Set the FRL Pressure to maximum PSI as listed on Pressure/Torque Conversion Chart.
2. Fully engage the torque wrench socket on the nut.
3. Either place the reaction arm firmly against a stationary surface or engage the LoaDisc Driver over the reaction washer.

Figure 11. Using the jGun with a Reaction Washer

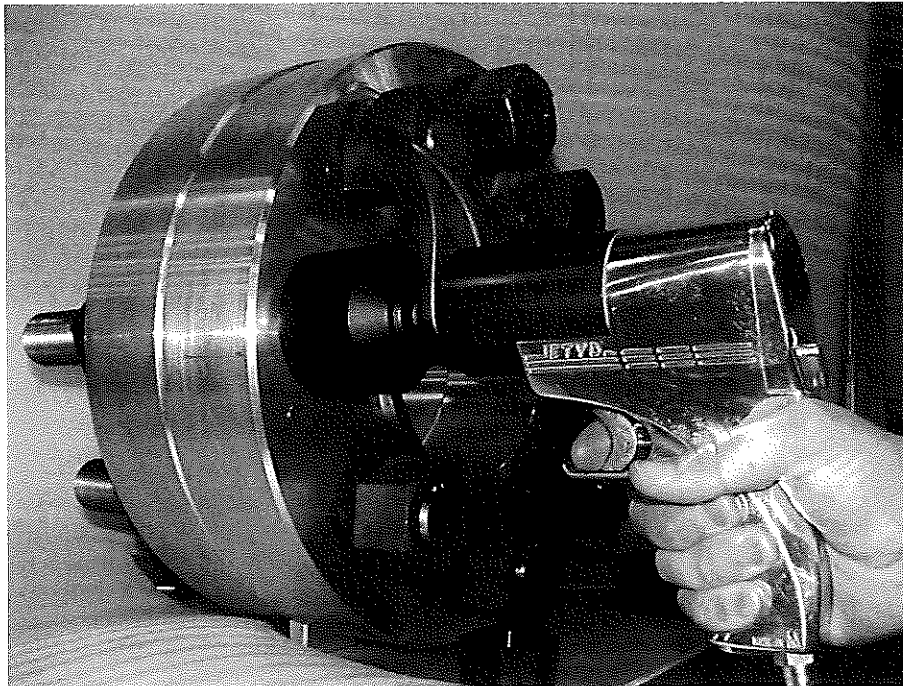

4. Ensure the torque wrench is set to the loosening direction.
5. Remove the fastener.

jGun Repair and Maintenance

Although the FRL Unit keeps the jGun self-maintained by continuously provided pneumatic tool oil to the tool during operation, proper repair and preventative maintenance will ensure the full life span of your tool.

Maintaining Hoses and Fittings

- Visually inspect air lines and air line fittings before tool use
- Replace worn or leaking air lines
- Tighten leaky fittings

**CAUTION**

Loose fittings can be potentially dangerous when pressurized. Over tightening fittings can cause permanent thread failure.

Loose fittings or over tightened fittings can cause personal injury and tool damage.

Ensure that air line fittings are tight, but not overly tight.

Removing the Square Drive

You may remove the square drive for replacement or exchange between different drive types. (Allen Drives, Clamp Drives, etc.) To remove the drive end:

1. Disengage the continuous snap ring at the base of the square drive above the splined section. The ring can be removed by prying the overlapping segment with a small flat-head screwdriver.

Figure 12. Removing the jGun Square Drive Snap Ring

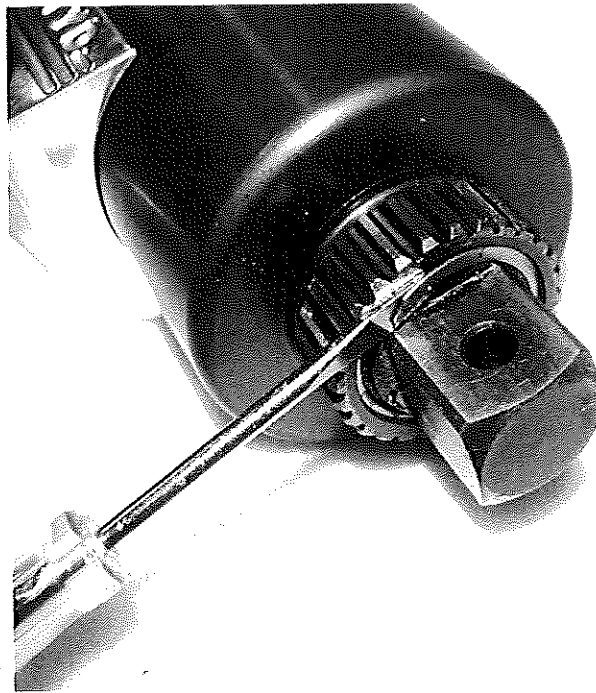

2. Once the first section is out, continue prying small sections until the entire ring can be removed.
3. Once the retaining ring is removed, the square drive can be pulled out.
4. If necessary, a screwdriver or other small bar can be placed through the hole in the square drive for leverage when removing the drive.

Installing the Square Drive

To install the square drive:

1. If the split bushing is already on the square drive, proceed to step 3.
2. Apply a thin layer of grease over the square drive, between the splined area and the shoulder.
3. Using pliers, spread apart the ends of the split bushing until the opening is large enough to pass over the splined end of the square drive. Insert the bushing over the square drive until it rests between the splined area and the shoulder.

Note: Do not distort the circularity of the split bushing; opening the bushing too far will affect the function of the bushing.

4. Using a wrench or pliers, squeeze the bushing to close it.
5. Keeping the bushing closed, use a soft mallet to tap the square drive until it begins to descend into the gearbox.

Note: Ensure the square drive can spin in place, either by turning it by hand or using a screwdriver inserted through the hole.

6. Continue to tap down the square drive until it is fully inserted. The shoulder of the square drive should sit below the retaining ring groove in the gearbox housing.

Note: The splined end of the square drive must be fully mated with the internal gears of the gearbox. To ensure this, turn the square drive while tapping it down.

7. Insert the retaining ring for the square drive. Ensure that it is fully seated in the retaining ring groove in the gearbox housing.

Lubricating the Air Motor

To lubricate the air motor:

1. Turn the jGun upside down and disconnect the air hose at the hose coupling connection.
2. Pour approximately one ounce of air tool oil, or spray a lubricant, into the hose coupling on the gun.
3. Reconnect the hose and operate the gun, while standing clear of the exhaust opening at the base of the handle. Excess lubricant will release from this opening upon initial operation.

Removing the Air Motor

To remove the air motor:

1. Remove the small set screw from the directional lever on the back cover of the gun.
2. Pull the lever off of the gun,
3. Remove the four Allen screws on the back cover of the gun.
4. Next remove the back cover and the gasket underneath.
5. Pull the motor straight back; it is not pressed in. It may come apart, but be careful not to lose the guide pin.
6. Assemble in the reverse order of disassembly.

Calibration

JETYD provides a pressure / torque conversion chart with every tool. The stated accuracy is +/- 5%. If you properly maintained your tool and keep it in good working condition, it will stay within this stated accuracy. Proper maintenance procedures can be found in this JETYD Operations Manual.

If the torque required is for a critical application or if the torque output is in question, the torque accuracy or output of a tool can and should be verified through calibration. Calibration is available by JETYD Corporation for a minimal fee.

Dual Speed jGun

The dual speed jGun is the newest implementation of our pneumatic torque wrenches. It gives a user the ability to select whether they want to run the tool with high speed or with maximum torque. Physically, the dual speed gun is identical to the standard jGun with the exception of a handle which guides the shifting mechanism.

Figure 13. Dual Speed jGun with Handle

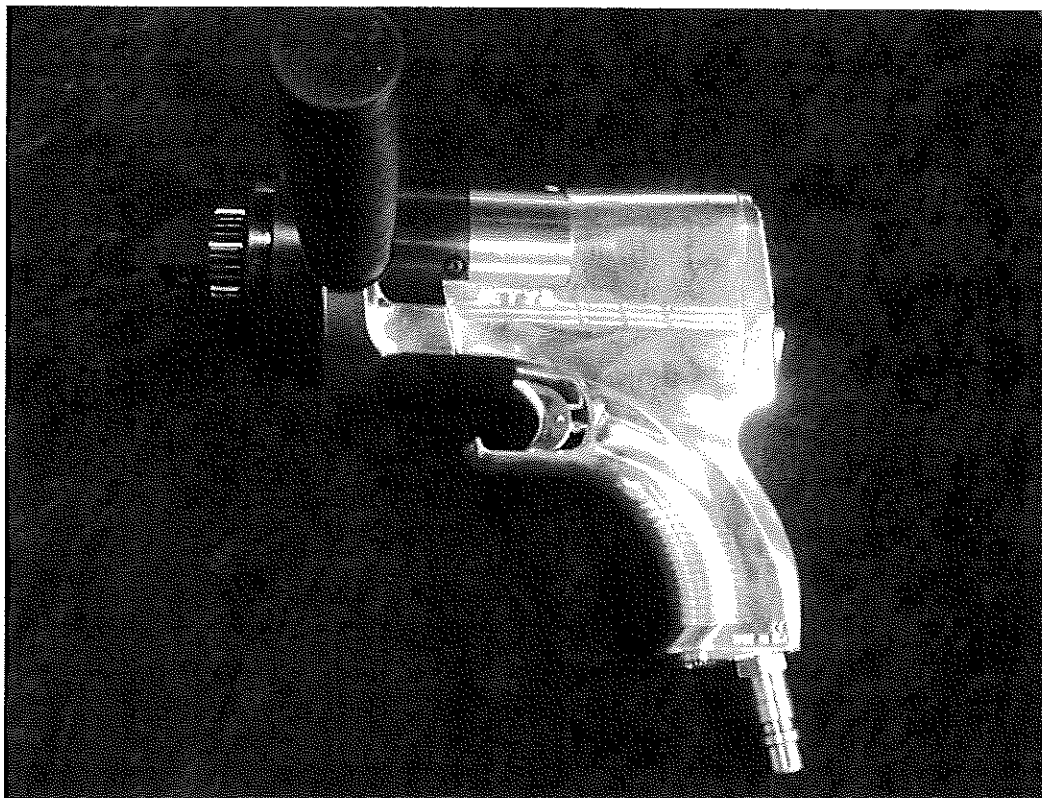

The handle shown above can be positioned on either side for right or left handed operation.

Shifting Between Modes

The dual speed gun has two settings: High Speed and Maximum Torque

Figure 14. Maximum Torque Setting (Left) and Maximum Speed Setting (Right)

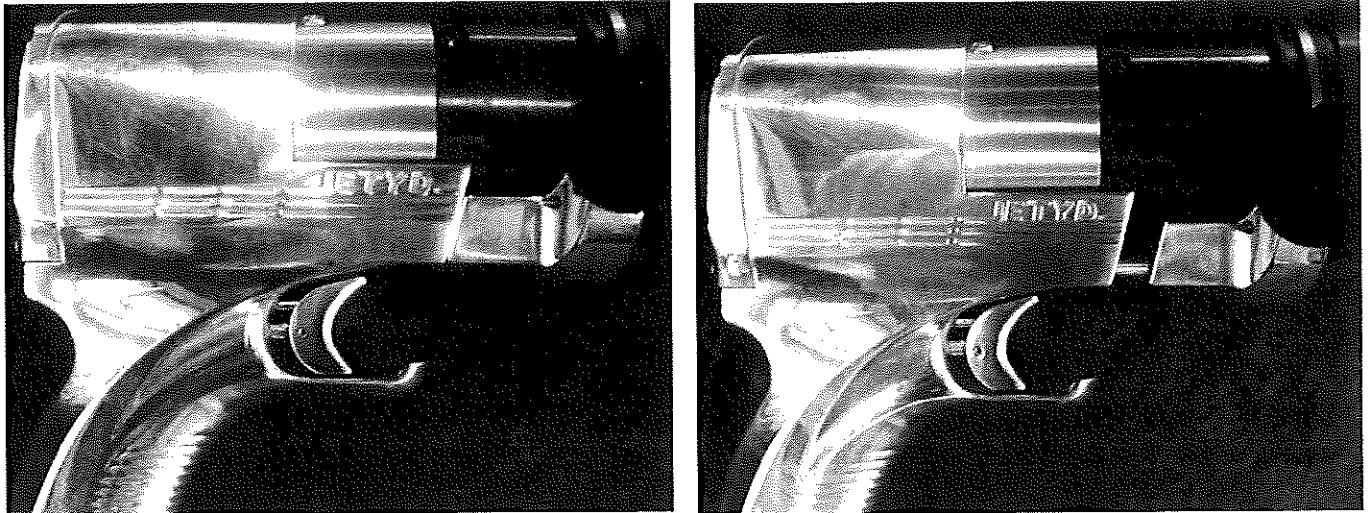

Maximum Torque Setting

- This mode is activated when the tool is in its initial position (Figure 14 – left photo), where the shifter is back against the body of the gun.
- Operation during the maximum torque mode is similar to that of the single speed jGun. The torque is applied until the bolts reach the desired load for any specific application.

High Speed Setting

- Shifting into high speed requires pushing the handle forward as shown (Figure 14 – right photo). Once engaged, the housing will rotate with the square drive at a much higher rate than the maximum torque setting.
- Use this feature when you want to run nuts on or off studs in a quick and efficient manner.



NOTE

When shifting between High Speed and Maximum Torque modes, make sure the tool is stopped and fully engaged in either the forward or backward position. Failure to fully engage tool may affect the operation of the tool and ultimately result in loss of control and/or damage to the tool.

Tool Operation

Before operating the tool, be sure to follow the safety precautions listed in jGun Safety on page 1.



▲ CAUTION

Keep loose clothing or jewelry away from the tool as loose items may interfere with tool while it is in motion and possibly cause injury.

Operation with a Socket and Reaction Arm

Read this section carefully before proceeding.

The dual speed gun requires using a special reaction arm provided with the tool by the Jetyd Company. This arm includes:

- A snap fitting which secures the tool on the housing
- A stopper that prevents accidental mode shifting.

Figure 15. Reaction Arm for dual-speed jGun

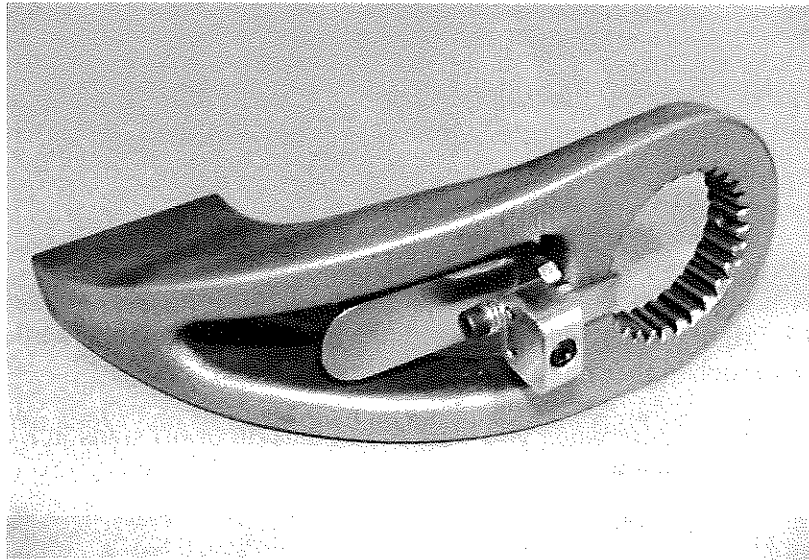

▲ CAUTION



DO NOT USE ANY OTHER REACTION ARM WITH THE DUAL SPEED GUN THAN THE ONE PICTURED ABOVE.

PROCEDURE:

- Initially, the reaction arm should be left off the tool until all the nuts are run down to their desired position. During high speed operation the Dual Speed jGun should only be equipped with the locking pin, the retaining ring, and the socket.
- Push the handle forward and make sure the tool is set for High Speed operation. Use the tool to run the nuts down the stud.
- Once the nuts are run down to their final position, pull the lever back to set the tool into its Maximum Torque mode. Once engaged, the tool behaves in the same manner as the single speed tool.
- Remove the jGun socket and install the reaction arm as shown in Figure 15. Remember that the reaction arm must be locked with easy snap lock.
- After setting up the Dual Speed jGun with a reaction arm, torque the nuts to the desired load.

▲ CAUTION

Remember, a reaction arm should never be used with the dual speed gun when it is in its high speed mode. Failure to comply with this warning may result in injury as the tool may spin out of control and possibly cause physical injury.

▲ CAUTION

The Reaction Arm should never be used with the tool when it is in its high speed mode. Failure to comply with this warning may result in injury as the tool may spin out of control and possibly cause physical injury.

Operation with a Load Disc

- The LoaDisc socket should be removed from the jGun until the nuts are spun down to the correct depth. During high speed operation the Dual Speed jGun should only be equipped with the locking pin, the retaining ring, and socket.
- Place the tool in its High Speed Mode and spin the LoaDiscs down to the desired position. After completing this, run the standard nuts down until they reach the LoaDiscs already in place in the stud.
- Install the LoaDisc socket driver assembly provided. Refer to the LoaDisc Reaction Washer Overview for any further questions about setup.
- Once the LoaDisc socket driver assembly is properly installed, place the jGun over the nut and LoaDisc and tighten until operator reaches the desired torque.

jGun Single Speed Parts Diagram

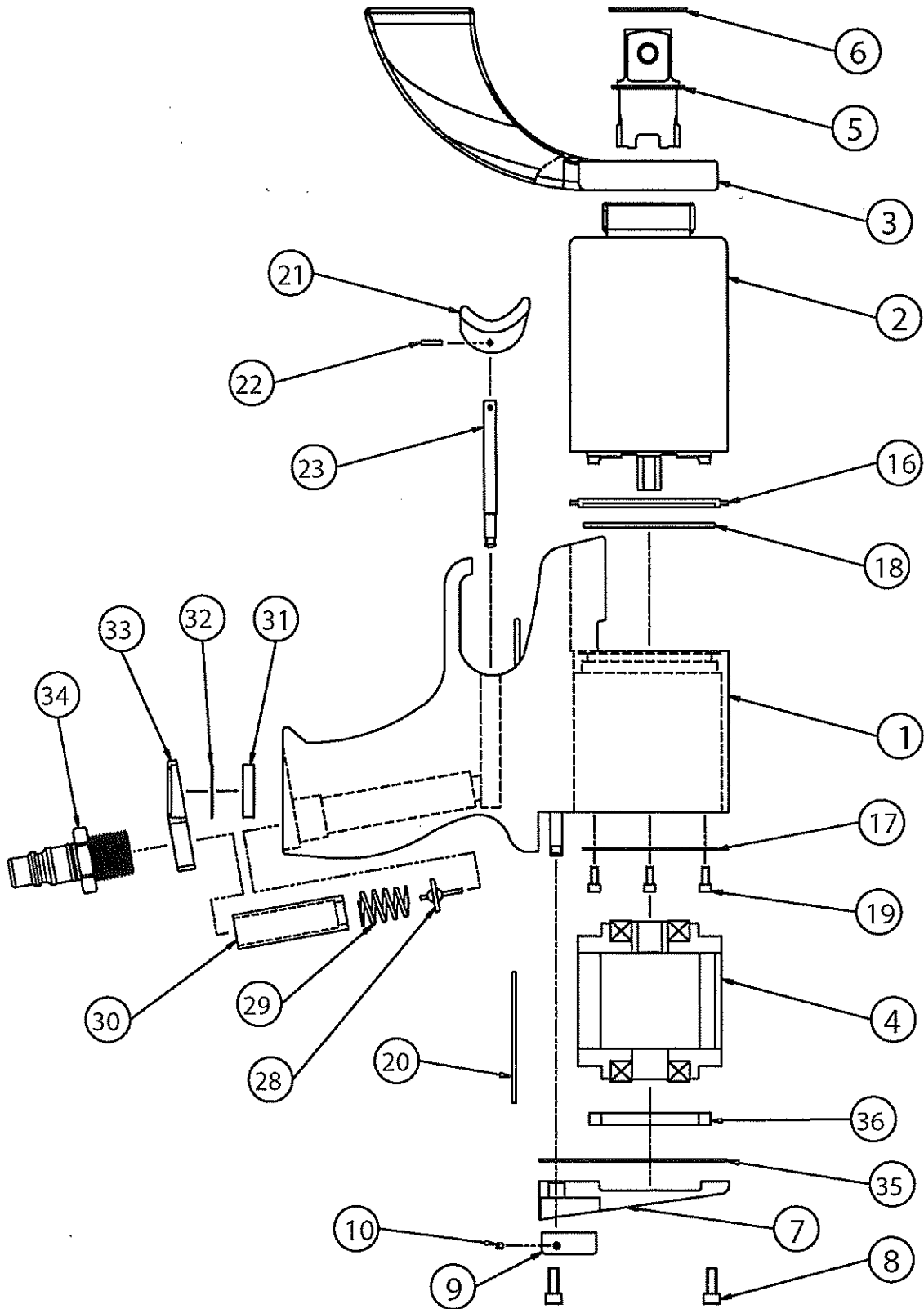

jGun Single Speed Parts List

| <u>Item</u> | <u>Description</u> | <u>AIR P5</u> | <u>AIR 1</u> | <u>AIR 3</u> | <u>AIR 5</u> |
|-------------|------------------------------|---------------|--------------|--------------|--------------|
| 1 | Handle | JAS0-01 | JAS0-01 | JAS3-01 | JAS5-01 |
| 2 | Gearbox | JAP5-02 | JAS1-02 | JAS3-02 | JAS5-02 |
| 3 | Reaction Arm | JOS0-03 | JOS0-03 | JOS3-03 | JOS5-03 |
| 4 | Motor | JA00-04 | JA00-04 | JA00-04 | JA05-04 |
| 5 | Square Drive | JOS0-05-010 | JOS0-05-010 | J003-05-020* | J005-05-080* |
| 6 | Retaining Ring for Sq. Dr. | J000-06 | J000-06 | J003-06* | J005-06* |
| 7 | Back Cover | JA00-07 | JA00-07 | JA00-07 | JA05-07 |
| 8 | Screws for Back Cover (x4) | JA00-08 | JA00-08 | JA00-08 | JA05-08 |
| 9 | Directional Switch | JA00-09 | JA00-09 | JA00-09 | JA00-09 |
| 10 | Screw for Directional Switch | JA00-10 | JA00-10 | JA00-10 | JA00-10 |
| 16 | Spacer for Gearbox | JAS0-16 | JAS0-16 | - | - |
| 17 | Retaining Ring for Gearbox | J000-17 | J000-17 | J003-17 | JOS5-17 |
| 18 | O-Ring for Gearbox | JA00-18 | JA00-18 | JAS3-18 | JAS5-18 |
| 19 | Screws for Gearbox (x4) | J000-19 | J000-19 | J003-19 | JOS5-19 |
| 20 | Motor Guide Pin | JA00-20 | JA00-20 | JA00-20 | JA05-20 |
| 21 | Trigger | JA00-21 | JA00-21 | JA00-21 | JA00-21 |
| 22 | Roll Pin for Trigger | J000-22 | J000-22 | J000-22 | J000-22 |
| 23 | Trigger Rod | JA00-20 | JA00-20 | JA00-20 | JA05-20 |
| 28 | Main Valve | JA00-28 | JA00-28 | JA00-28 | JA00-28 |
| 29 | Spring for Main Valve | JA00-29 | JA00-29 | JA00-29 | JA00-29 |
| 30 | Inlet Spacer for Main Valve | JA00-30 | JA00-30 | JA00-30 | JA00-30 |
| 31 | Noise Filter | JA00-31 | JA00-31 | JA00-31 | JA00-31 |
| 32 | Mesh Screen | JA00-32 | JA00-32 | JA00-32 | JA00-32 |
| 33 | Bottom Plate | JA00-33 | JA00-33 | JA00-33 | JA00-33 |
| 34 | Male 3/8" NPT Coupling | JA00-34 | JA00-34 | JA00-34 | JA00-34 |
| 35 | Gasket for Back Cover | JA00-35 | JA00-35 | JA00-35 | JA05-35 |
| 36 | Gasket for Motor | JA00-36 | JA00-36 | JA00-36 | JA05-36 |

*Must Be Installed at Factory

jGun Dual Speed Parts List

| <u>Item</u> | <u>Description</u> | <u>AIR DUAL 1</u> | <u>AIR DUAL 3</u> | <u>AIR DUAL 5</u> |
|-------------|---------------------------------|-------------------|-------------------|-------------------|
| 1 | Handle, Main Housing | JAD1-01 | JAD3-01 | JAD5-01 |
| 2 | Gearbox | JAD1-02 | JAD3-02 | JAD5-02 |
| 3 | Reaction Arm | J0D1-03 | J0D3-03 | J0D5-03 |
| 4 | Motor | JA00-04 | JA00-04 | JA05-04 |
| 5 | Square Drive | J0D1-05-010 | J003-05-020 | J005-05-080 |
| 6 | Retaining Ring for Square Drive | J000-06 | J003-06 | J005-06 |
| 7 | Back Cover | JA00-07 | JA00-07 | JA05-07 |
| 8 | Screws for Back Cover (x4) | JA00-08 | JA00-08 | JA05-08 |
| 9 | Directional Switch | JA00-09 | JA00-09 | JA00-09 |
| 10 | Screw for Directional Switch | JA00-10 | JA00-10 | JA00-10 |
| 16 | Spacer for Gearbox | - | - | - |
| 17 | Retaining Ring for Gearbox | J000-17 | J003-17 | J0D5-17 |
| 18 | O-Ring for Gearbox | JA00-18 | - | - |
| 19 | Screws for Gearbox (x4) | J000-19 | J003-19 | J0D5-19 |
| 20 | Motor Guide Pin | JA00-20 | JA00-20 | JA05-20 |
| 21 | Trigger | JA00-21 | JA00-21 | JA00-21 |
| 22 | Roll Pin for Trigger | J000-22 | J000-22 | J000-22 |
| 23 | Trigger Rod | JA00-20 | JA00-20 | JA05-20 |
| 28 | Main Valve | JA00-28 | JA00-28 | JA00-28 |
| 29 | Spring for Main Valve | JA00-29 | JA00-29 | JA00-29 |
| 30 | Inlet Spacer for Main Valve | JA00-30 | JA00-30 | JA00-30 |
| 31 | Noise Filter | JA00-31 | JA00-31 | JA00-31 |
| 32 | Mesh Screen | JA00-32 | JA00-32 | JA00-32 |
| 33 | Bottom Plate | JA00-33 | JA00-33 | JA00-33 |
| 34 | Male 3/8" NPT Coupling | JA00-34 | JA00-34 | JA00-34 |
| 35 | Gasket for Back Cover | JA00-35 | JA00-35 | JA05-35 |
| 36 | Gasket for Motor | JA00-36 | JA00-36 | JA05-36 |
| 40 | Shifter Handle | J0D1-40 | J0D0-40 | J0D0-40 |
| 41 | Shifter | J0D1-41 | J0D3-41 | J0D5-41 |
| 42 | Shifting Sleeve | J0D1-42 | J0D3-42 | J0D5-42 |
| 43 | Guide Screws for Shifter (x2) | J0D1-43 | J0D3-43 | J0D5-43 |
| 44 | Bearings for Shifter (x3) | J0D0-44 | J0D0-44 | J0D0-44 |
| 45 | Shims for Bearings (x3) | J0D0-45 | J0D0-45 | J0D0-45 |
| 46 | Screws for Bearings (x3) | J0D0-46 | J0D0-46 | J0D0-46 |
| 47 | Shifting Balls (x8) | J0D0-47 | J0D0-47 | J0D0-47 |

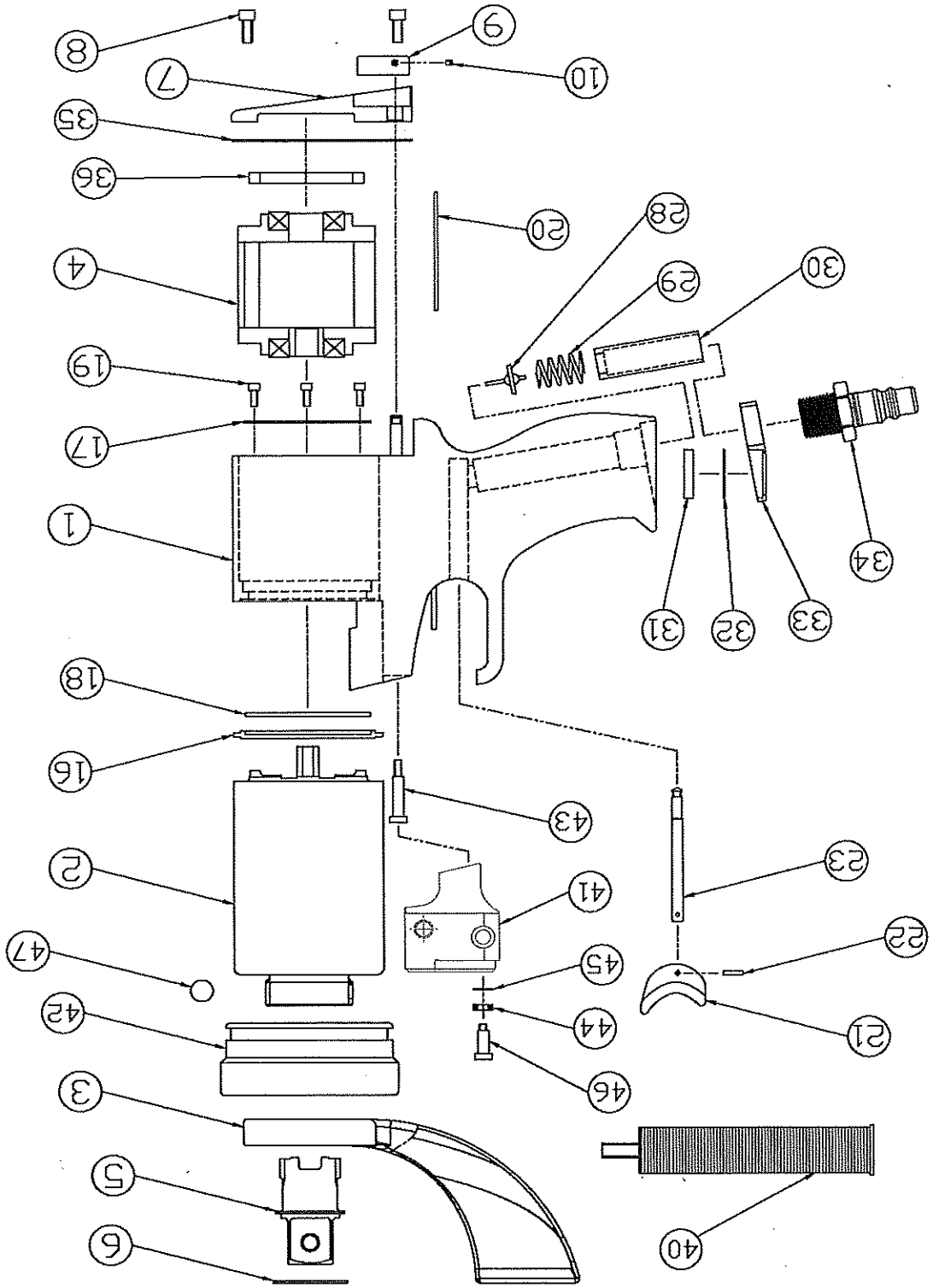

Jgun Dual Speed Parts Diagram

Filter/Regulator/Lubricator (FRL) Unit Overview

A Filter/Regulator/Lubricator (FRL) Unit is provided with every jGun and must be used in conjunction with the tool. In addition, the FRL Unit must be used with the 12' hose provided for connection to the jGun to ensure the tool's durability. The FRL Unit removes water and foreign material from your air supply, regulates the air pressure, and mixes pneumatic tool oil into the air to keep your jGun lubricated.

Operating the jGun without the FRL Unit will void the warranty and may cause damage to the air motor and gearbox. Incorrect setting of the lubricator unit may result in a shortage of lubrication to the air motor and gearbox resulting in damage to the tool.

Figure 16. FRL Unit

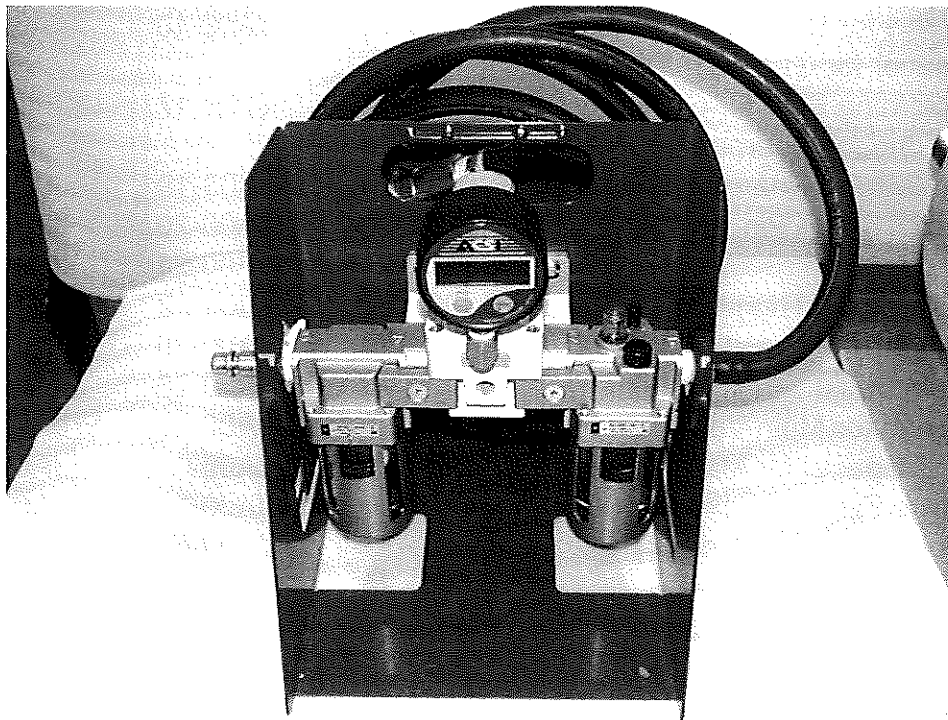

FRL Safety

Only qualified personnel who have thoroughly read this document may operate this tool. Failure to safely operate this tool may result in serious injury or death.

- Inspect all FRL components as they are removed from the shipping container. If damage is found to any component, contact your shipper immediately. Do not use the tool.
- Failure to follow correct tool usage could result in personal injury, co-worker injury, and/or damaged tools and equipment.
- Ensure that your working area is clean and unobstructed before beginning work.

- FRL maintenance and repair must be performed by a qualified pneumatic technician.
- Modifying an FRL or FRL accessory is dangerous and invalidates the warranty.
- Inspect the unit before each use. Replace any obviously worn or damaged parts.
- When not in use, properly store the FRL, hoses and couplers.

Personal Protective Equipment

- Always wear the appropriate personal protective equipment when operating the FRL and jGun including gloves, safety goggles, hearing protection, hard hat, and safety shoes

Air Supply Requirements

- Air supply line must be ½-inch minimum diameter to allow adequate air flow to the jGun
- Air supply must be 90 PSI @ 30 CFM minimum.
- Ensure that air line fittings are tight and leak free. Do not over tighten air line fittings.
- Always use the FRL Unit provided with the jGun. Never use a substitute oiler and regulator with a jGun.

NOTE

Set the air pressure while the tool is running as described in the Setup and Use section.

- Open the air supply connected to the FRL unit and run the torque wrench while setting the pressure on the gauge.
- Set the air pressure to the PSI needed to achieve desired torque shown on the provided pressure/torque conversion chart.

FRL Setup and Use

Proper setup and use of the FRL unit will ensure accurate results and safe operation. The three components of the FRL must be checked individually to ensure correct operation.

- Empty the filter reservoir before use.
- Press the ZERO button on the regulator gauge before setting the operating pressure.
- Adjust the lubricator flow properly.
- Fill the lubricator reservoir with pneumatic tool oil (provided with the FRL unit).

Important FRL Operating Procedures

- Only operate the unit with the air flow moving in the direction indicated by the arrows on top of the unit.
- Empty the filter reservoir before each use to remove water and sediment.
- Fill the lubricator reservoir only with pneumatic tool oil before each use.
- Adjust the lubricator flow to one (1) drop per ten (10) seconds (shortage of lubrication may cause motor to seize).
- Use only the hose provided with the FRL for connection to the unit; a change in hose length may affect tool durability and accuracy.

Emptying the Filter Reservoir

You may empty the filter reservoir of water and foreign material in two ways:

- Emptying water through the release valve on the underside of the reservoir. To use the release valve, push the valve until the water or debris drains out of the reservoir.
- Removal of the reservoir. To remove the reservoir from the FRL unit:
 - a. Push down on the black square button to unlock the reservoir.
 - b. Twist the filter reservoir until the two lines on the FRL body and the filter reservoir are aligned.

Figure 17. Emptying the FRL Filter Reservoir

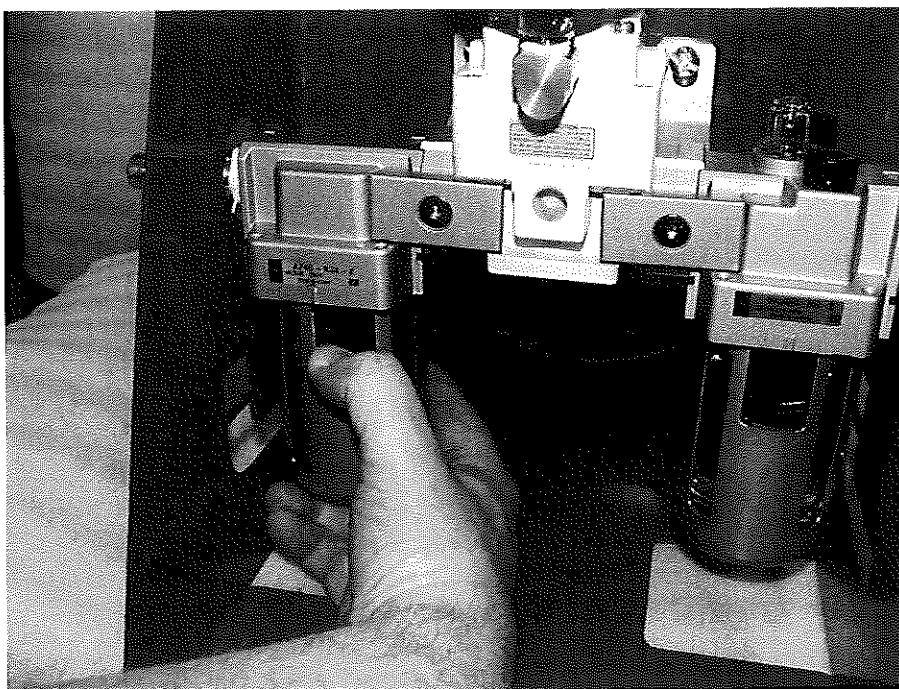

- c. Pull the filter reservoir down to detach from lubricator body.
- d. Discard the contents of the filter reservoir.

Figure 18. Detaching FRL Reservoir

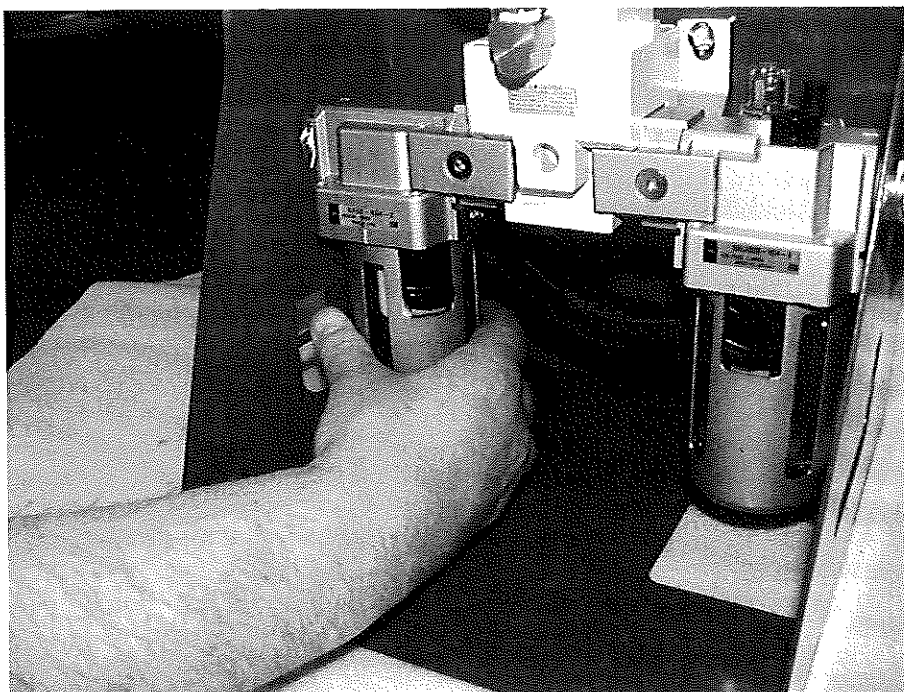
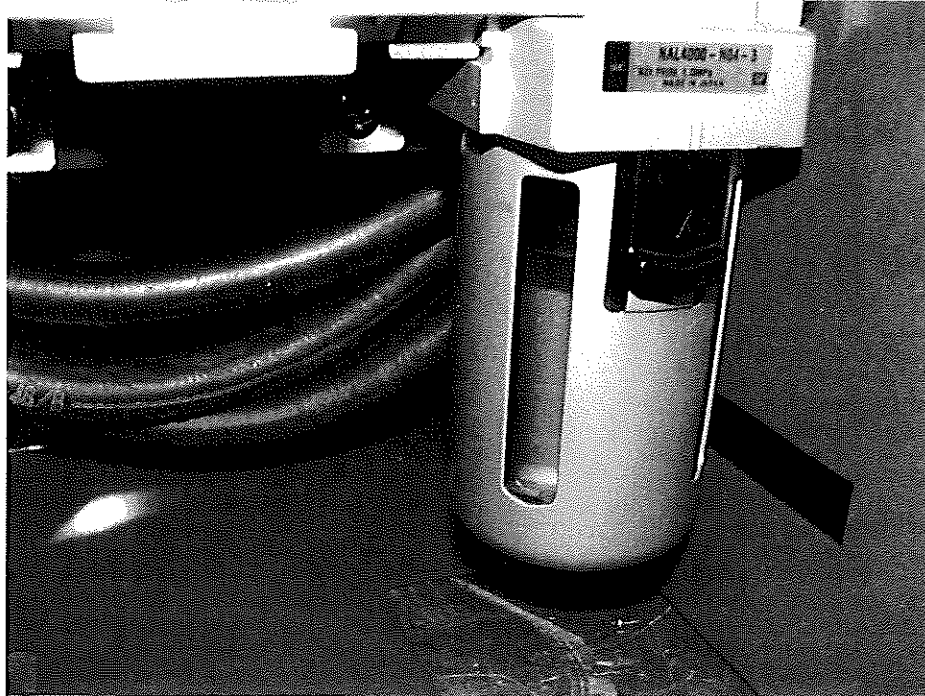

Figure 19. FRL Unit – Lubricator 2/3rds Full of Oil



- e. If needed, refill the reservoir as described on page 31.
- f. Reattach the lubricator by aligning the lines on the filter reservoir and FRL body, and pushing up on the reservoir, then twisting the reservoir to lock it in place. The black locking button should snap into its original position.

Adjusting Air Pressure

To adjust the air pressure at the regulator:

1. If you are using a digital gauge, press the ON button on the gauge, then press the ZERO button to set the reading to zero. Do not press the ZERO button when the system is under pressure.

Figure 20. Adjusting FRL Regulator

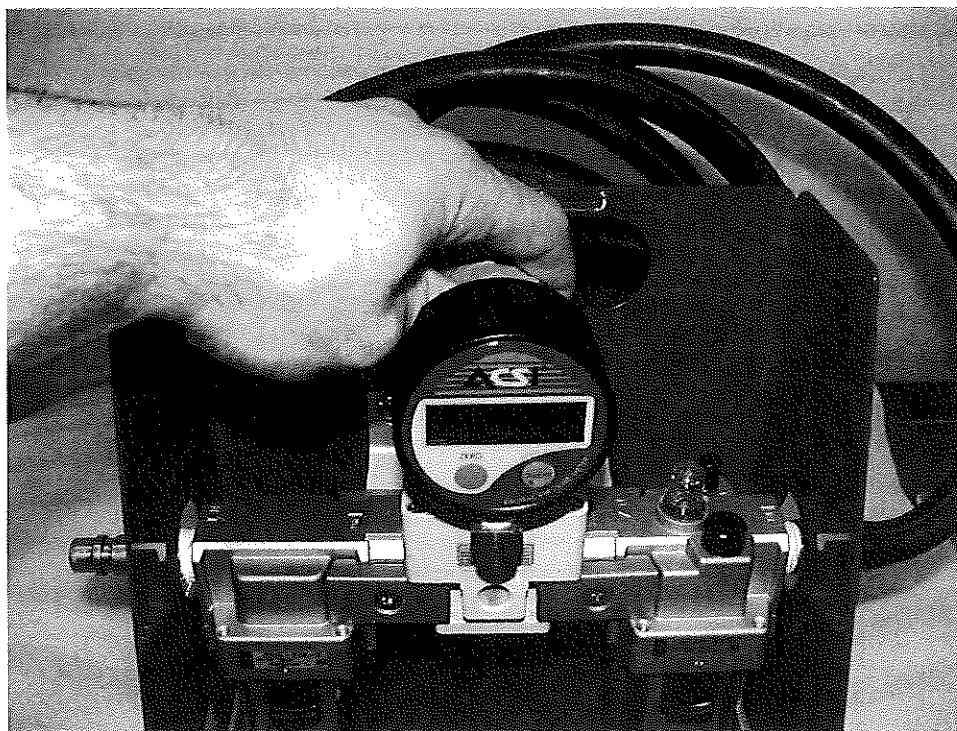

2. A Torque Chart is provided with each tool which gives the conversion from air pressure (PSI) to torque (ft-lbs and N-m). Use the chart to determine the air pressure needed to achieve desired torque output.
3. Connect your air supply to the FRL, and press the ON button to view current air pressure.
4. While operating the tool, turn the regulator knob clockwise to decrease pressure and counter-clockwise to increase pressure. Allow 30 seconds for the digital gauge to settle.

Filling the Lubricator Reservoir

To fill the lubricator reservoir:

1. Push the black square button down to unlock the reservoir.
2. Twist the lubricator reservoir until the two lines on the lubricator body and the lubricator reservoir are aligned.
3. Pull the lubricator reservoir down to detach it from lubricator body.
4. Pour pneumatic tool oil into the reservoir until it is about two-thirds full.
5. To reattach the lubricator, realign the lines on the lubricator reservoir and main body, then push the two pieces together and twist the reservoir to lock in place.

Adjusting the Flow

To adjust the oil flow of the FRL device:

1. Remove any attachments from the tool.
2. Run the tool while watching the rate at which oil drips through the acrylic view-glass on the lubricator unit.

Figure 21. Adjusting FRL Oil Flow

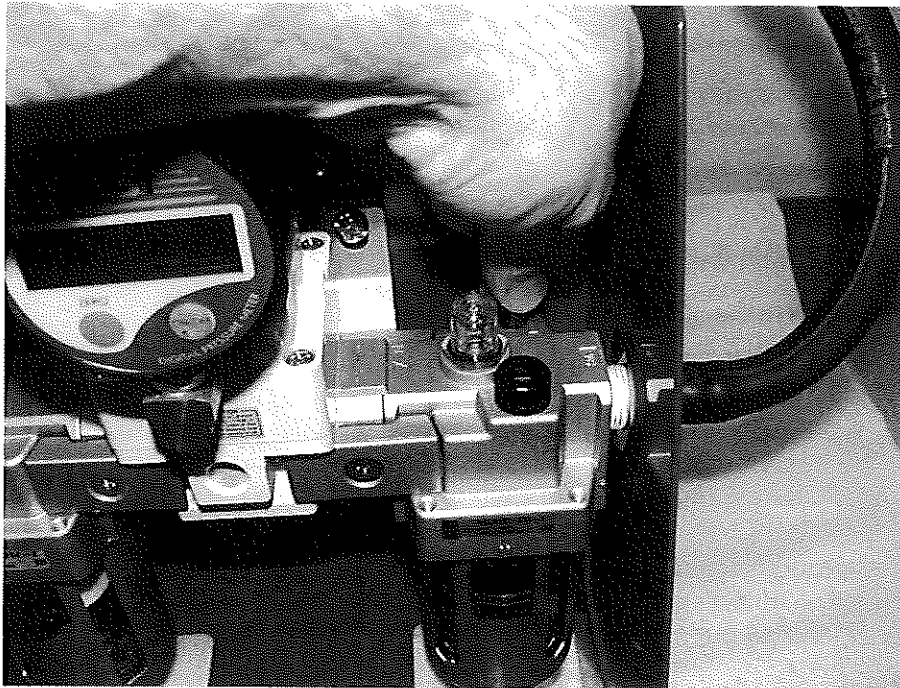

3. Turn the flow adjustment knob clockwise or counter-clockwise until the oil is dripping at a rate of at least one drop every ten seconds.

Repair and Maintenance

Although the FRL is a self-contained unit and does not require heavy maintenance, proper repair and preventative maintenance will ensure the life span of the unit.

Hoses and Fittings

- Visually inspect air lines and air line fittings before tool use
- Replace worn or leaking air lines
- Tighten leaky fittings



CAUTION

Loose fittings or over tightened fittings can cause personal injury and

tool damage.

Ensure that air line fittings are tight, but not over tight.

LoaDisc Reaction Washer Overview

The LoaDisc Reaction Washer is the first reaction arm replacement device for torque wrenches and is exclusive to JETYD Corporation. The LoaDisc is a hex shaped washer that fits under a standard nut and is used in conjunction with a double-layered (concentric) socket. The double-layered socket turns the nut using the inner socket, and the gun reacts on the washer with the outer socket.

Figure 22. LoaDisc Washer and Socket

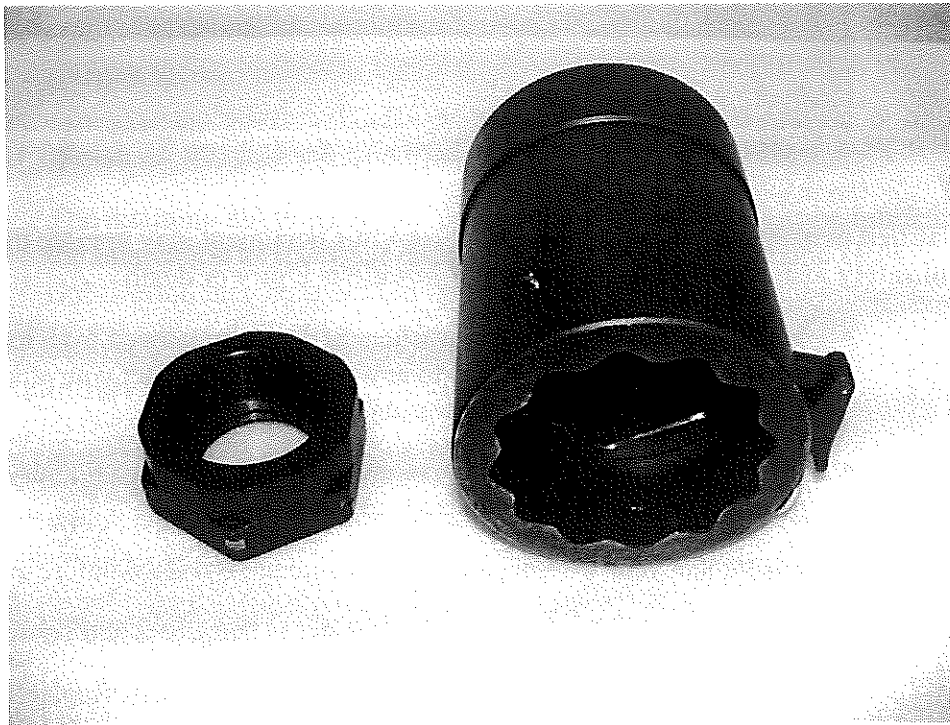

In addition to the added safety of having no external moving parts, the LoaDisc system provides a universal reaction point for all applications, eliminating the need for custom-designed reaction arms. Concurrently, the threaded segment inside of the washer stops the bolt from turning, eliminating the need for back-up wrenches. By reacting and tightening on the same axis, side-load is eliminated and surface friction from nut-to-nut is equalized, giving you increased bolting accuracy.

Figure 23. LoaDisc Socket Mounted on jGun

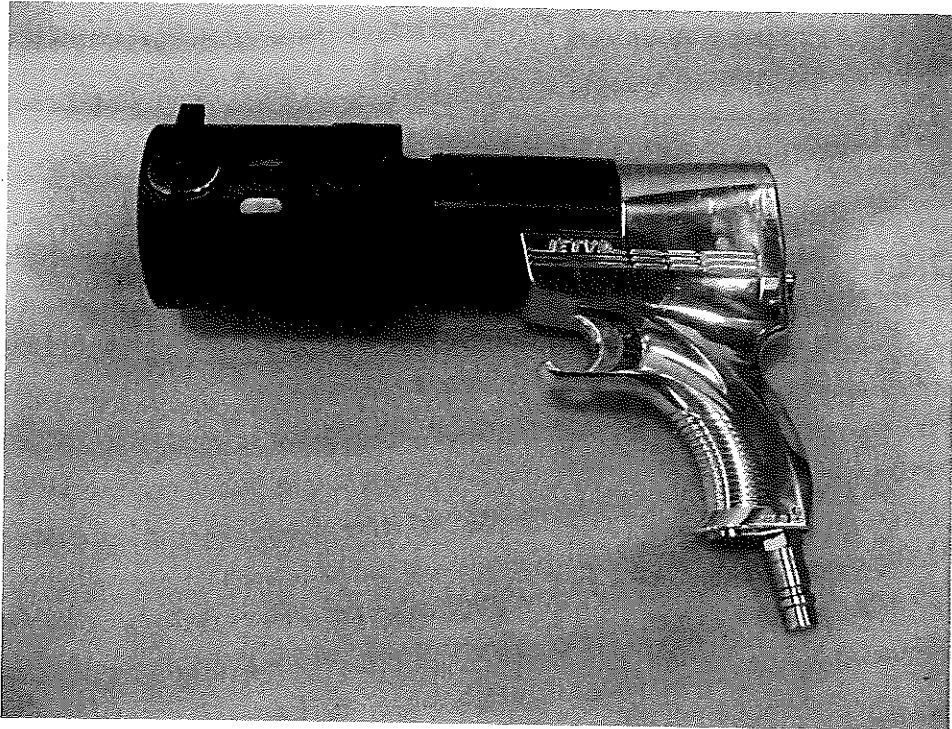

Safety

Only qualified personnel who have thoroughly read this document may operate this system. Failure to safely install the LoaDisc may result in serious injury or death.

- Inspect all LoaDisc reaction washers as they are removed from the shipping container. If damage is found to any component, contact your shipper immediately. Do not use the washer.
- Failure to follow correct tool usage could result in personal injury, co-worker injury, and/or damaged tools and equipment.
- Ensure that your working area is clean and unobstructed before beginning work.
- Modifying a LoaDisc washer or accessory is dangerous and not recommended.
- Inspect the LoaDisc and LoaDisc driver before each use. Replace any obviously worn or damaged parts.
- When not in use, properly store the LoaDisc drivers and any unused LoaDiscs.

Personal Protective Equipment

- Always wear the appropriate personal protective equipment when operating the FRL and jGun including gloves, safety goggles, hearing protection, hard hat, and safety shoes.

LoaDisc Requirements

- Use the proper size LoaDiscs for the bolts and nuts you are using.
- All joint specifications (bolt size, material, gasket type, etc) must be provided or recorded by a trained JETYD Representative.
- Always use authentic JETYD accessories when installing the LoaDisc. Never use a substitute torque wrench or socket/driver.

LoaDisc Setup and Use

Proper setup and use of the LoaDisc reaction washer ensures accurate results and safe operation.

Important Preparation Procedures

- The joint and fasteners must be properly inspected and cleaned before LoaDisc installation.
- The joint surfaces, bolts, and nuts must be properly cleaned and dried before installation.
- The LoaDisc reaction washer must be completely dried and free of oil or grease.
- The retaining nut to be installed on top of the LoaDisc must be lubricated using the lubrication as specified on the torque/bolt load conversion chart (lubrication may be specified upon ordering for custom calibrations).

Important Installation Procedures

1. Insert the cleaned and dried bolt through the bolt hole.
2. Determine which side of the joint is optimal for tightening (a side providing adequate wrench space, light, accessibility, etc.)
3. Install the clean and dry nut on the side opposite of the one from which you will be tightening.
4. Install the LoaDisc on the side you will be tightening from by turning it clockwise down the bolt until it is firmly hand tight.

Figure 24. LoaDisc Washer Installed

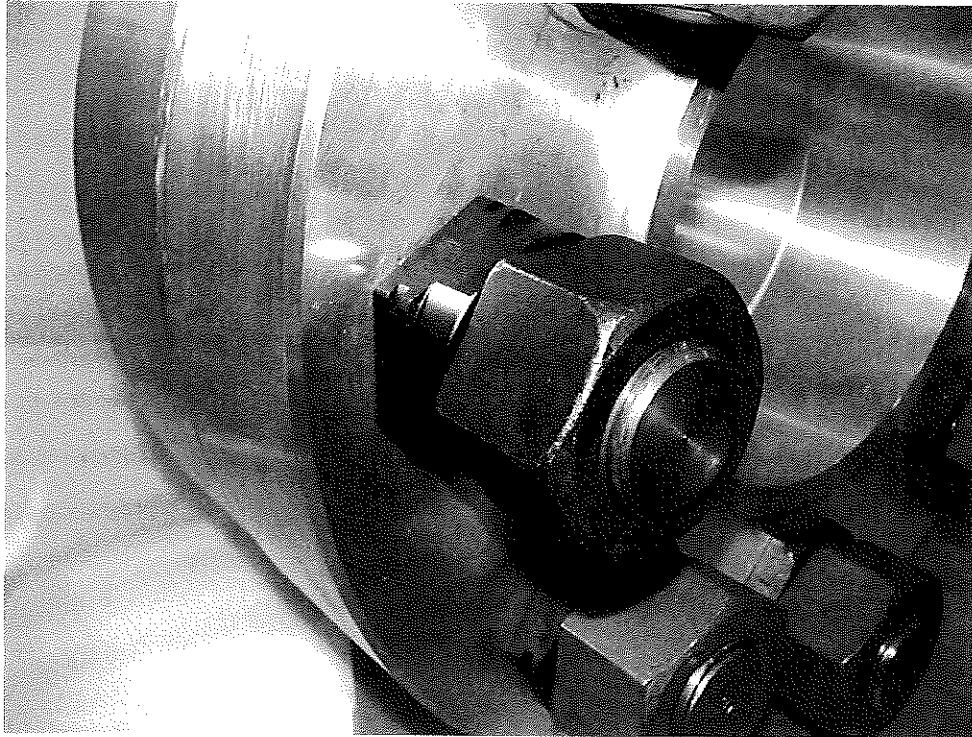

5. Install the lubricated nut by turning it clockwise down the bolt until it is firmly hand tight against the LoaDisc reaction washer.

NOTE

For proper installation only 3 or 4 threads should extend beyond the nut to be tightened.

6. After all bolts on the joint have been prepped for installation following the above steps, tighten the nut using a JETYD LoaDisc socket/driver.
7. Align the set screw on the socket with the drilled section on the splines of the jGun.

Figure 25. Aligning LoadDisc Socket Set Screw with Machined Recess in jGun Splines

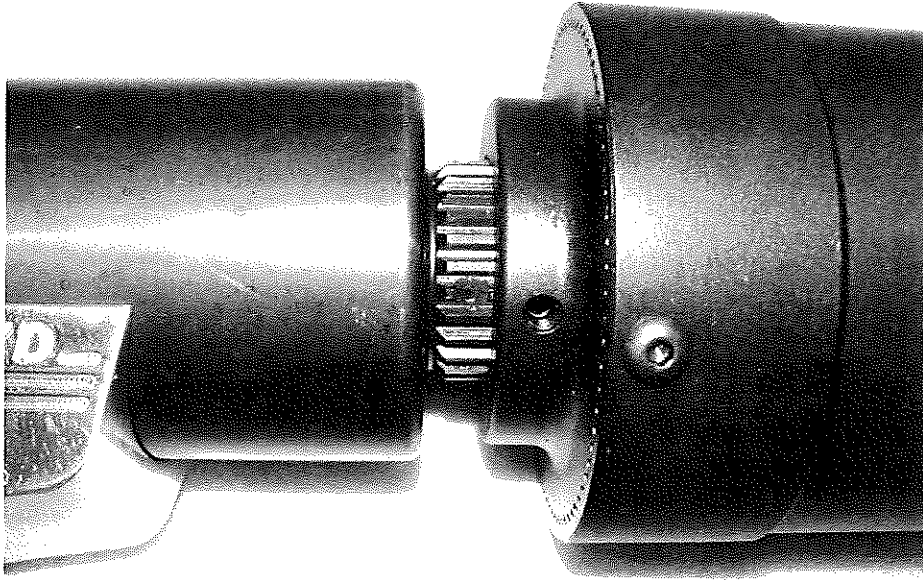

8. Tighten the set screw.

Figure 26. Tightening LoadDisc Set Screw

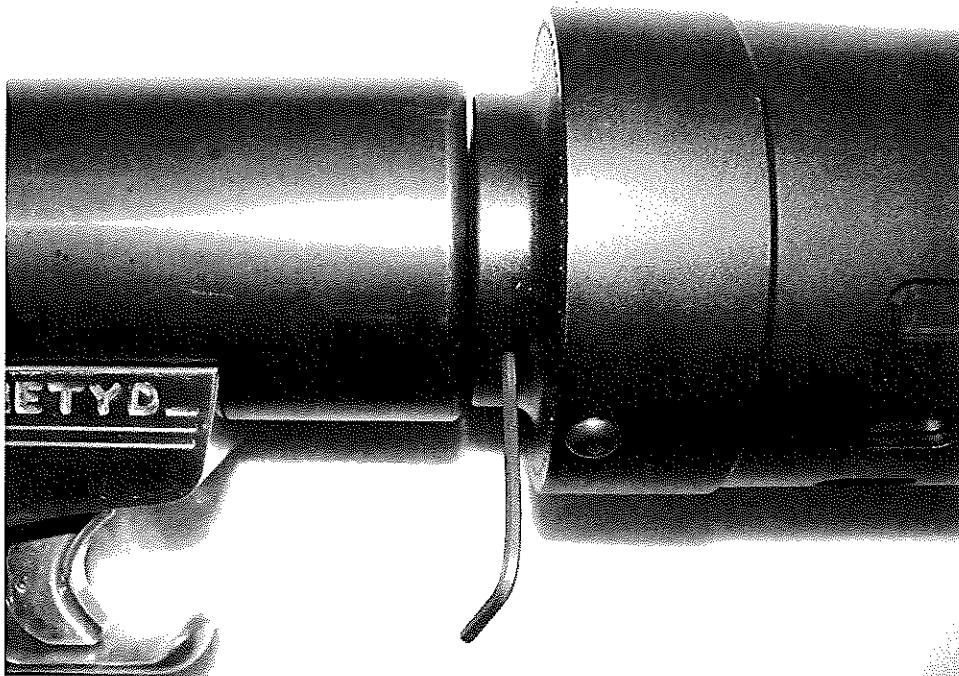

9. Place the double-socket LoadDisc driver over the nut and LoadDisc with the directional lever on the jGun set in the "T" direction for tightening.
10. Pull the trigger on the jGun to tighten the nut. (At start of installation the outer socket of the LoadDisc driver will make a short turn in the direction opposite of operation). Once the outer socket stops turning it will begin reacting on the washer as the inner socket turns the nut.
11. Continue pulling the trigger until drive stops turning. At this point, the desired torque or bolt load (as set on the pressure regulator of the FRL unit) is achieved.